

4

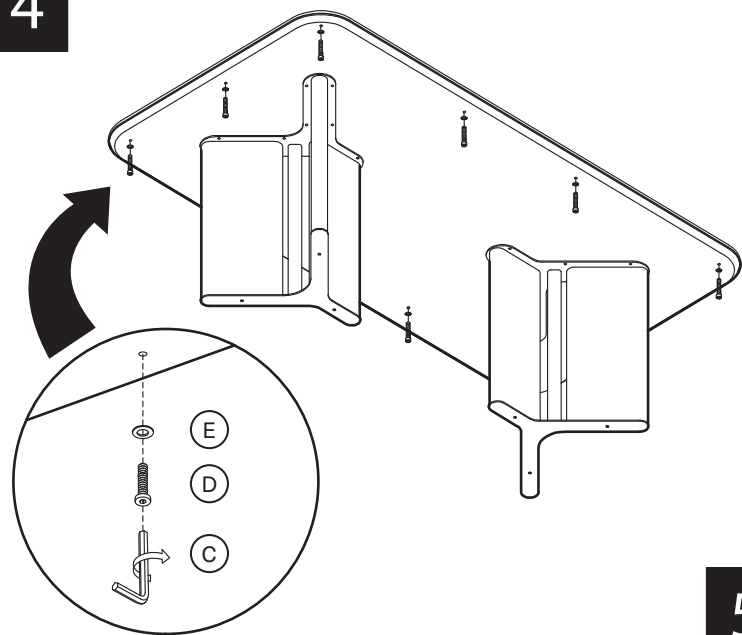

5

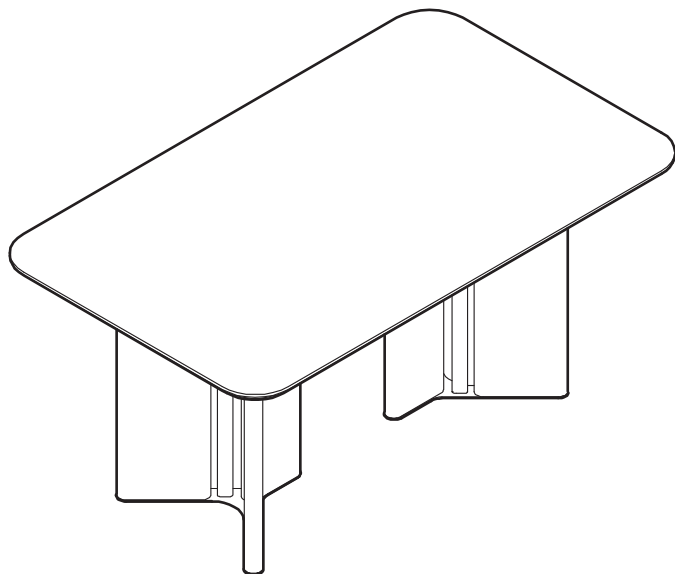

KOALA

L I V I N G

Assembly Instruction

Product Name: Sir Lionell II Gliding White Sintered Stone Rectangular Dining Table
Walnut Brown Wooden Legs 200x120cm

Product Id: 129988

Hardware List

- | | | | |
|---|--|--------------------------------|--------|
| A | | Allen Key
5mm | 1 pc |
| B | | Allen Bolt
8x20mm | 20 pcs |
| C | | Allen Key
4mm | 1 pc |
| D | | Allen Bolt
6x25mm | 10 pcs |
| E | | Washer
6x16mm | 10 pcs |
| F | | Stopper
(Already Assembled) | 6 pcs |

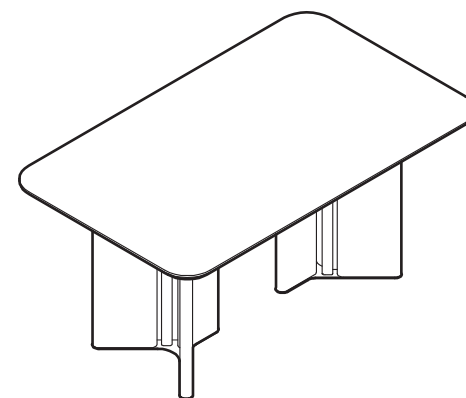

Part List

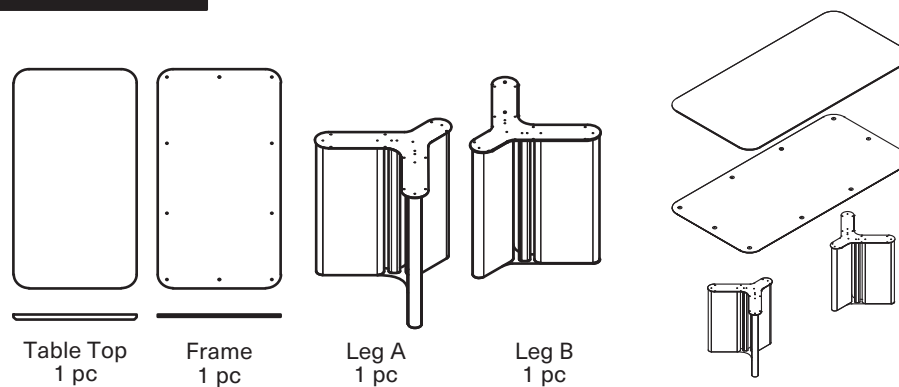

Note

1. Assemble the item on a soft, well-lit surface like cardboard or carpet.
2. For safety and efficiency, it's best to have two or more people assist with assembly to handle heavy parts safely and collaborate effectively.
3. Keep all packaging materials intact until assembly is complete.
4. Before assembling the item, carefully read all provided instructions.
5. Handle tools with care during assembly to prevent injuries.

1

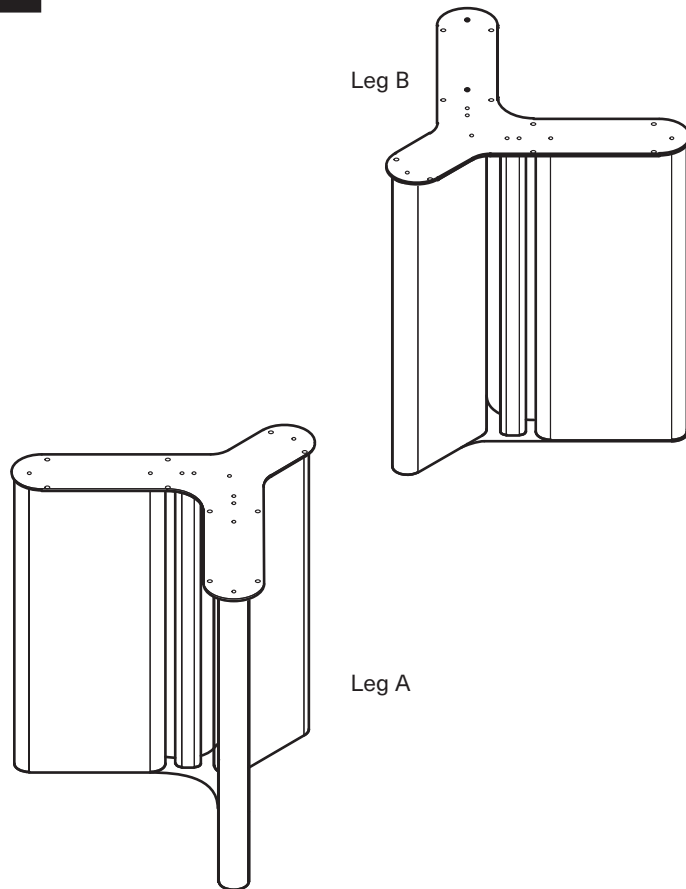

2

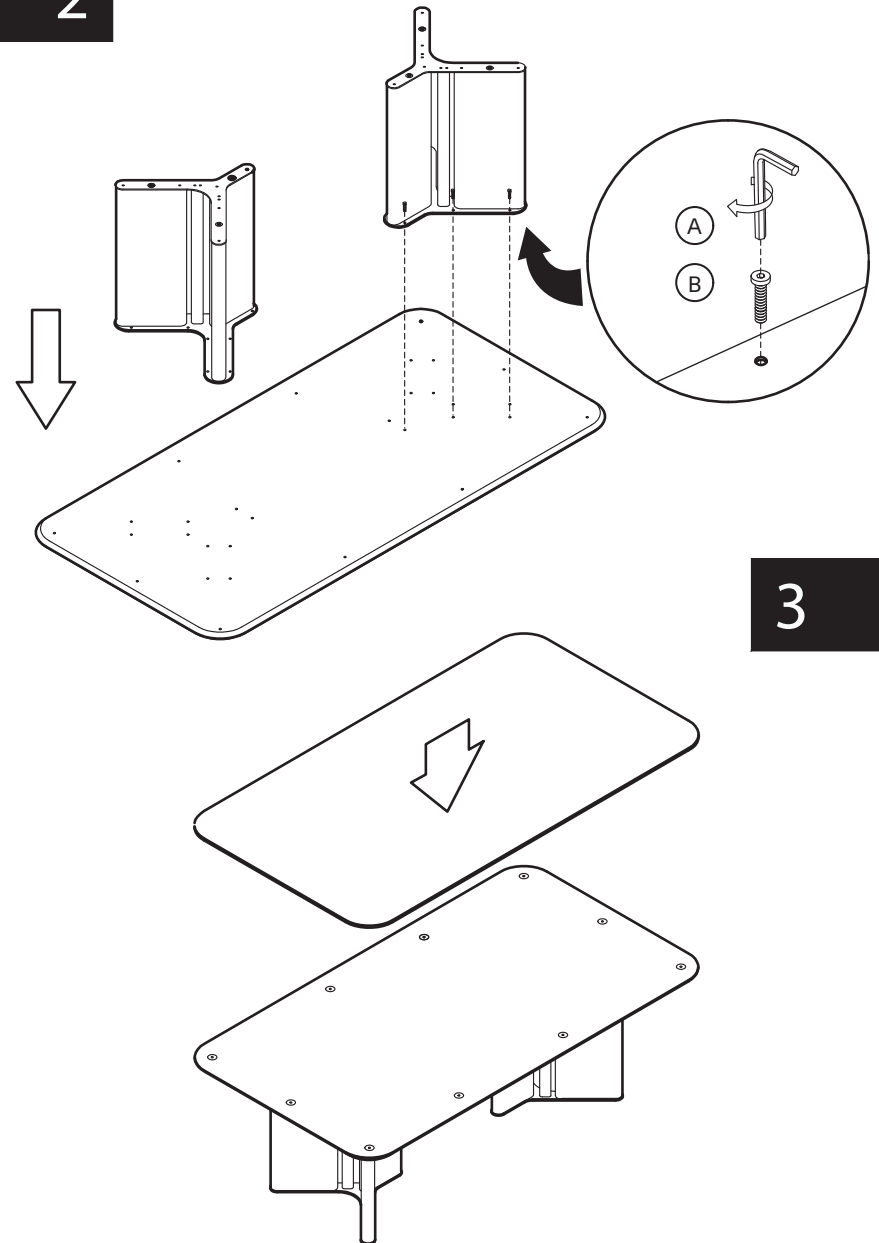

3