

# KOALA

## L I V I N G

### Assembly Instruction

Product Name: Heinrich Shelf

#### Hardware List

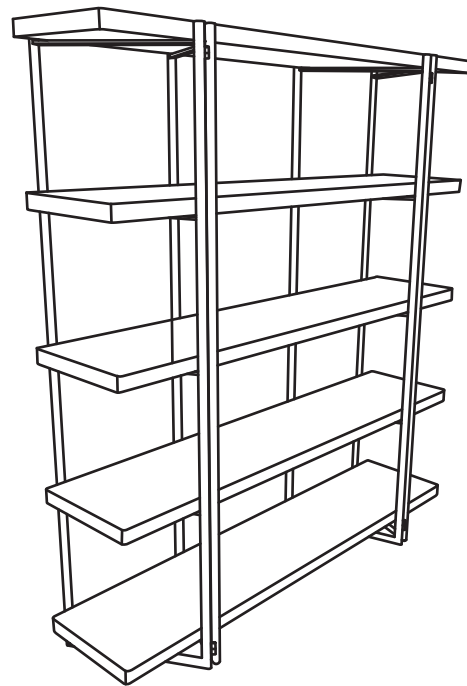
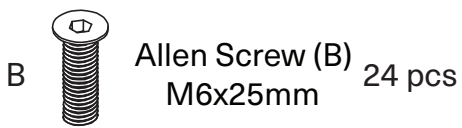

#### Parts List

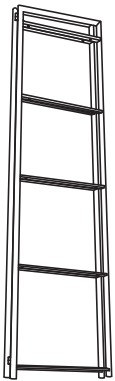

Leg A  
1 pc

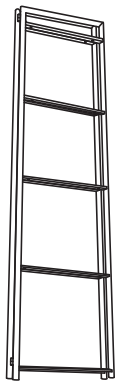

Leg B  
1 pc

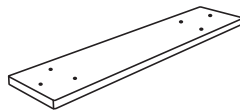

Shelf C  
2 pcs

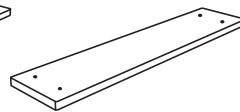

Shelf D  
3 pcs

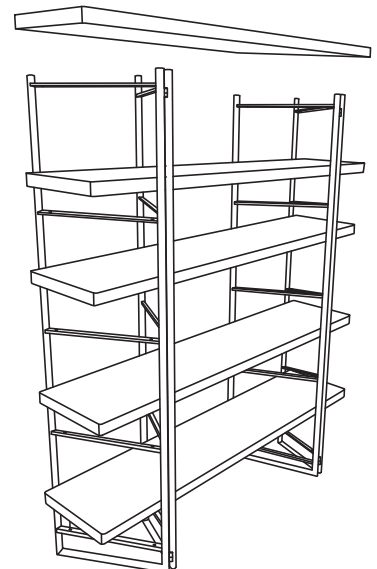

## Note

1. Please check that all required hardware for assembly, as listed in the instructions, is available before beginning assembly.
2. For safety and efficiency, it's best to have two or more people assist with assembly to handle heavy parts safely and collaborate effectively.
3. Do not discard any packaging materials until assembly is complete.
4. Before assembling the item, carefully read all provided instructions.
5. Handle tools with care during assembly to prevent injuries.
6. A drill may be used, but only on a LOW setting to avoid damage.

# 1

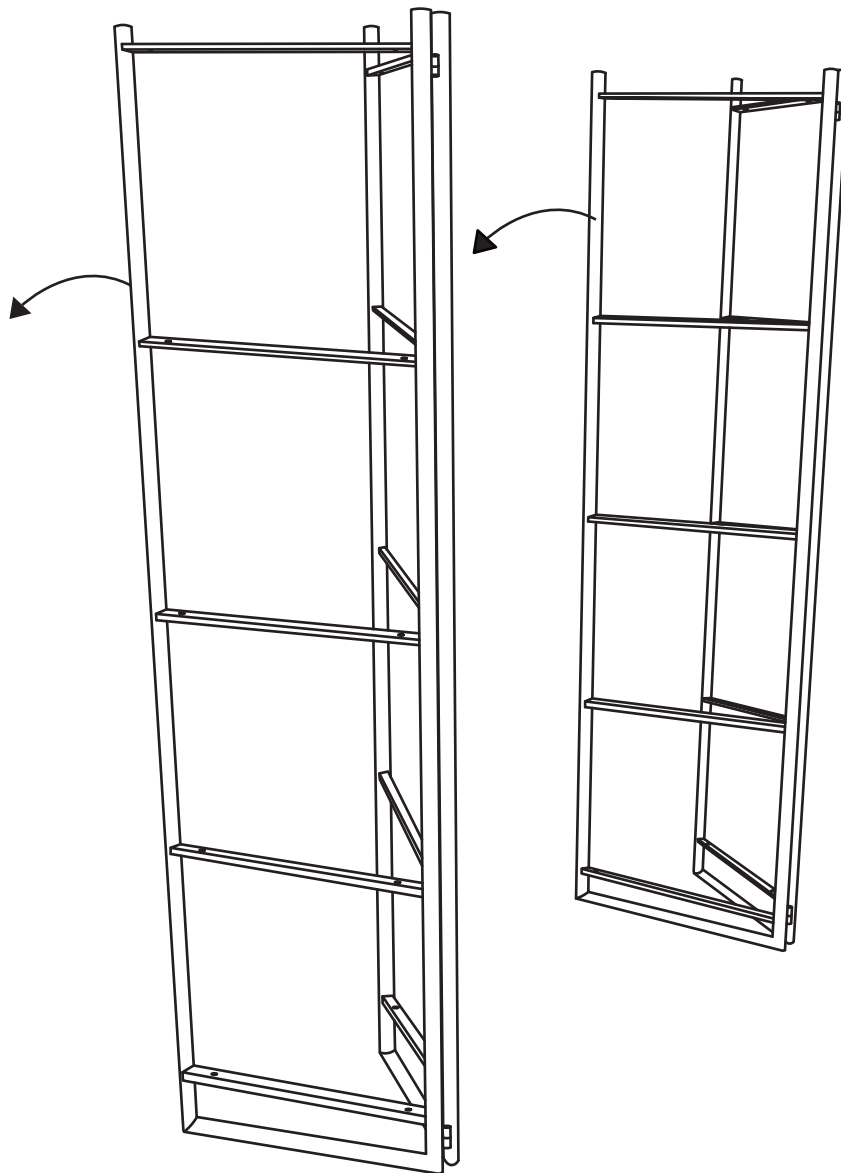

2

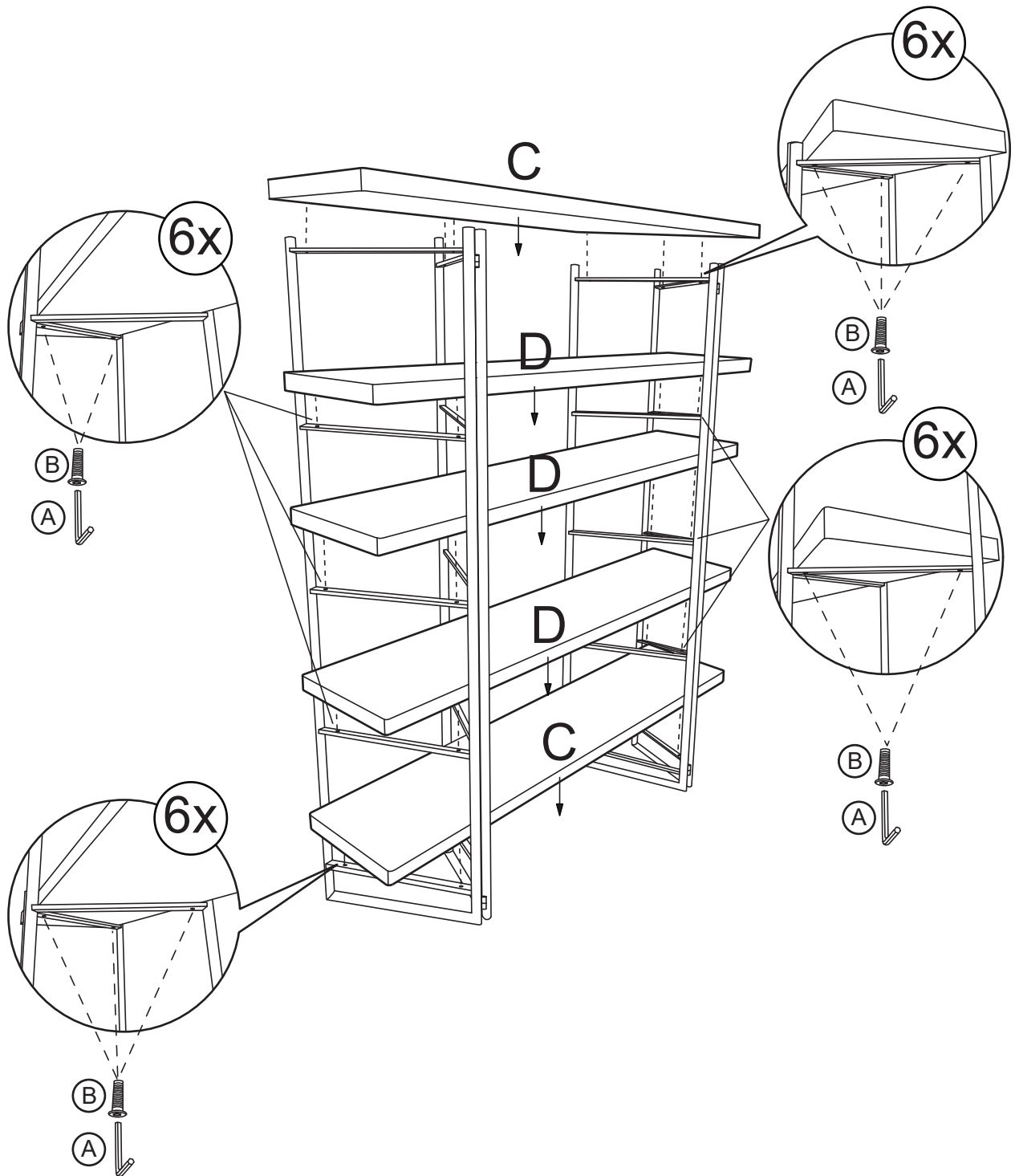

3

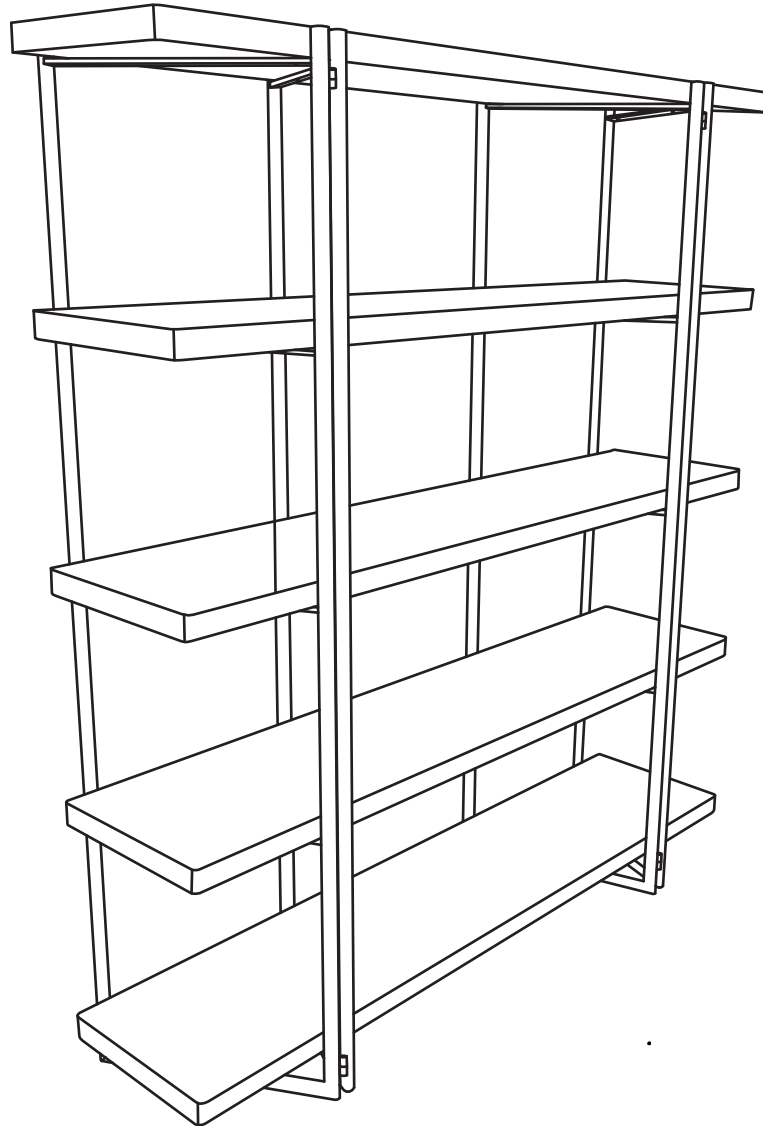

**⚠ Warning**

- ALWAYS secure this furniture with an anchor device
- NEVER allow children to stand, climb or hang on drawers, doors, or shelves
- ALWAYS secure your television with an anchor device

