

4

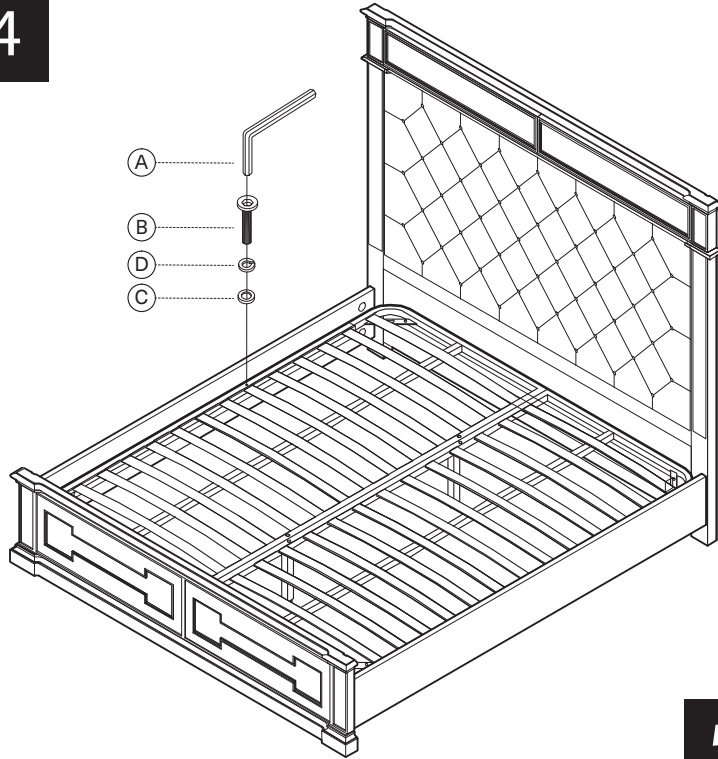

5

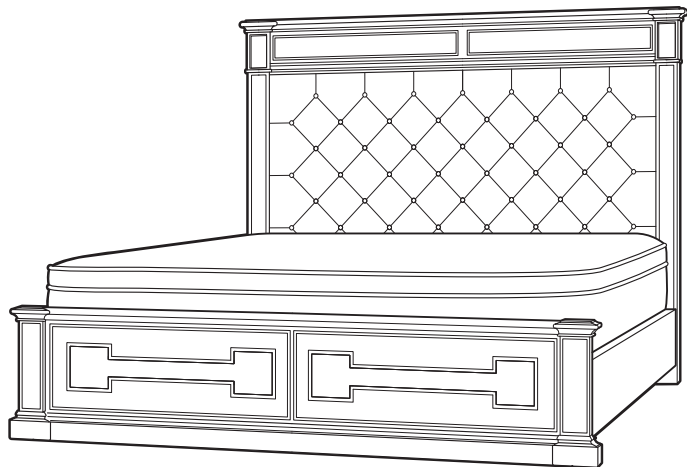

KOALA









L I V I N G

Assembly Instruction

Product Name: Solitude Antique Silver King Bed



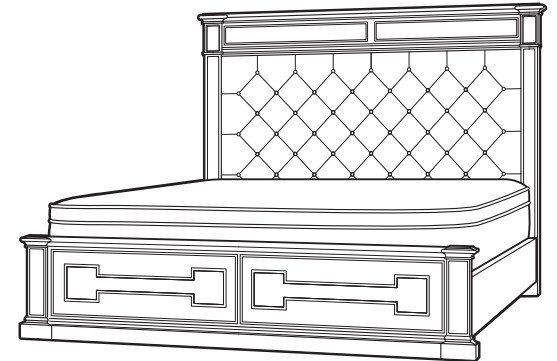

Product Id: 125736

Hardware List

A		Allen Wrench 5mm	1 pc
B		Allen Bolt 5/16"*50mm	6 pcs
C		Flat Washer 5/16"*19mm	6 pcs
D		Spring Washer 5/16"*12mm	14 pcs
E		Bolt 5/16"*8mm	12 pcs
F		Full Tooth Screw 5/16"*90mm	8 pcs
G		Half Crescent Pad 30*14*8mm	8 pcs
H		Flat Washer 5/16"*16mm	8 pcs
I		Wrench 87*14*2mm	1 pc

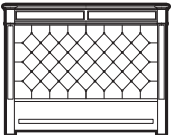

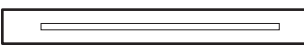
Part List

Headboard	Bedstead	Middle Leg	
			
1 pc	1 pc	2 pcs	
Rails		2 pcs	
Footboard		1 pc	

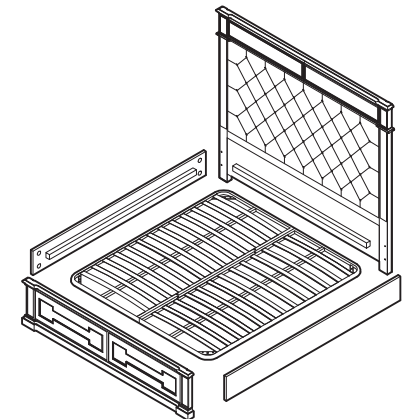

Note

1. Assemble the item on a soft, well-lit surface like cardboard or carpet.
2. For safety and efficiency, it's best to have two or more people assist with assembly to handle heavy parts safely and collaborate effectively.
3. Keep all packaging materials intact until assembly is complete.
4. Before assembling the item, carefully read all provided instructions.
5. Handle tools with care during assembly to prevent injuries.

1

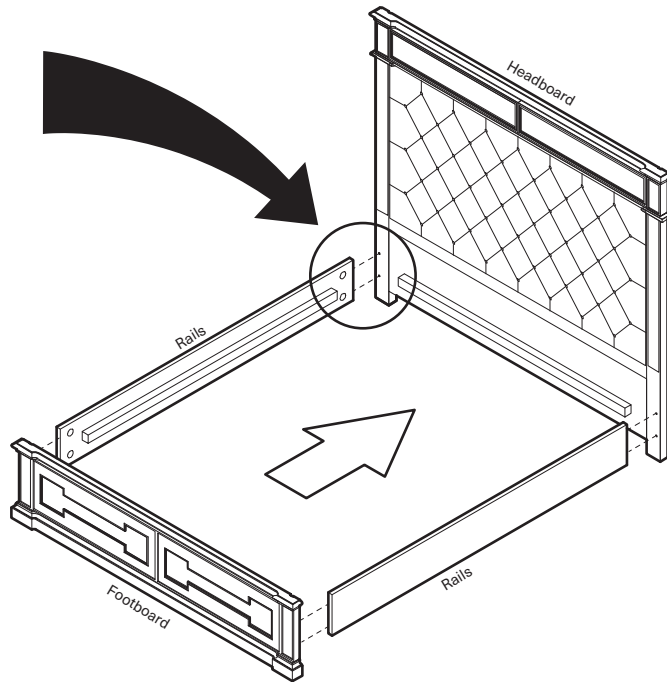
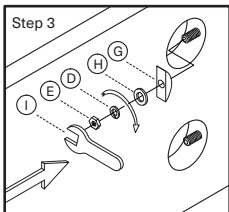
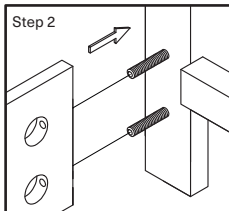
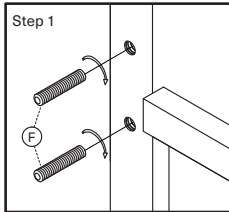

2

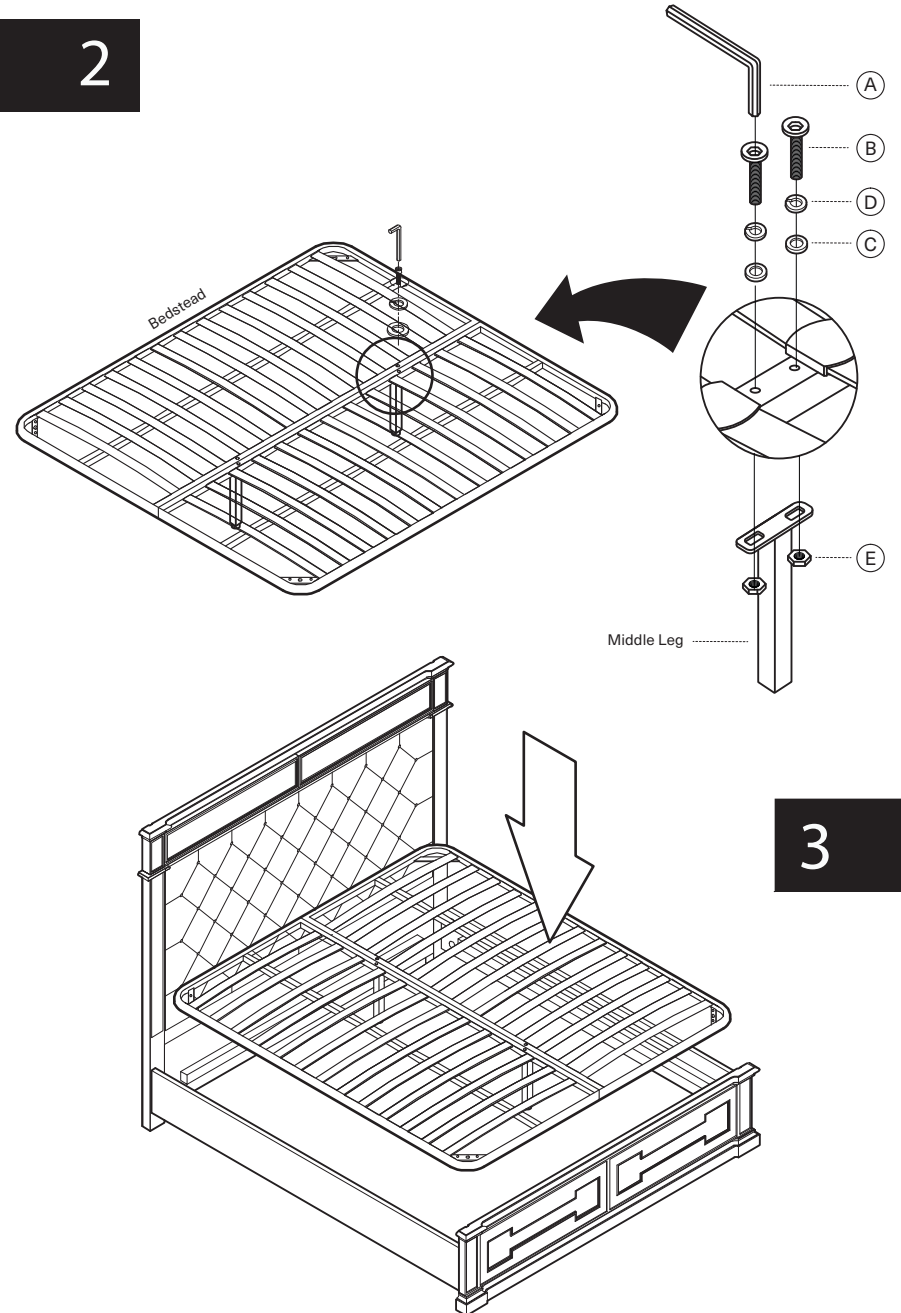

3